



# Ningbo Junke Metal Products Co., Ltd



## Ningbo Junke Metal Products Co., Ltd 宁波郡科金属制品有限公司

地址：中国宁波镇海区招宝山工业区静海路  
Add: Jinghai Road, Zhaobaoshan Industry Zone, Zhenhai District, Ningbo 315000, China  
手机/Tel: 0086 13757445098; 0086 13375743296  
传真/Fax: 0086 574 87028947;  
WhatsApp: 0086 13757445098; Skype:hzp811;  
Wechat: David811811;  
Email: 442582427@qq.com; salesjk@163.com;  
网址 /Website: www.jkmgrating.com



宁波

郡科

Ningbo Junke  
宁波郡科金属制品有限公司

[www.jkmgrating.com](http://www.jkmgrating.com)





# C 公司简介

## Company profile

宁波郡科金属有限公司位于中国宁波, 距离货物吞吐量世界第一的宁波舟山港仅20多公里, 区位优势明显. 公司产品可以在宁波, 上海港等港口出口.

宁波郡科金属是一家专业生产各种格栅板的大型知名生产厂家, 厂房占地10000余平方米, 拥有世界先进的PLC全自动钢格板生产线, 超过100位生产工人, 每年产量在10000吨左右. 主要产品生产范围包含: 热镀锌钢格板, 不锈钢钢格板, 玻璃钢格栅及制品, 铝合金格栅, 沟盖板, 踏步板, 扶手栏杆, 钢格板围栏, 安装夹具, 桥架, 等, 也可以根据客户需求私人订制. 我们的产品主要应用在石油化工, 钢结构平台, 市政工程, 矿山, 造船厂, 水厂电厂, 机场码头, 机器设备配套等工程项目. 产品长期出口美国, 澳大利亚, 欧洲, 中东, 日本, 南美及东南亚国家和地区.

公司技术力量雄厚, 拥有专业的钢格板设计人员和先进的AutoCAD设计系统, 能为广大客户提供最优的设计, 可根据客户要求进行现场测量, 设计, 生产, 并可以为客户进行现场安装服务. 本公司现已成为大型钢构企业和国家市政单位的首选, 中石化定点采购单位.

公司管理及生产按照国际标准执行, 并通过ISO9001-2008国际质量体系认证. 以质量第一, 客户至上为经营宗旨, 为每一位客户提供质优价廉的产品, 着力打造自己的知名品牌战略, 并一直深受广大国内外客户的青睐.



Ningbo Junke Metal Products Co., Ltd is located in Ningbo, the third seaport city in China. There is only about 20km to Ningbo international seaport. Meanwhile, our products also can be shipped out from Shanghai seaport.

Junke Metal is a famous grating factory in China, covering 10000 square meters, over 100 workers with two PLC automatic grating production lines, annual average production quantity is over 10000 tons.

We are a leading professional manufacturer of hot dip galvanized steel grating, fiberglass grating, stainless steel grating, stair treads ladder, trench grating, handrails and stanchions, grating fences, cable trays, grating clips and others relevant products. We also supply customized products according to the customer's special requirements. Our products is regularly exported into USA, AUS, Kuwait, UK, South America, Southeast, Africa and so on.

With strong technical power, there are more than ten high and middle grades professional technicians to supply best design service for the customers with specific AutoCAD designing system. Our friendly, knowledgeable team is sincerely committed to doing whatever it takes to meet customer expectations. Our grating is widely used in petroleum and chemical plants, steel structure platform, Municipal Engineering, oil projects, Boiler plant, wastewater treatment plant, Power plant, mine industry and so on.

ISO9001-2008 quality management system has been approved. Our goal is to help customers to provide a better metal products at lowest price, establish a long strategic term cooperation with each other.

If yours is a custom metal fabrication project, our technical experts will work closely with your architects, engineers, designers and other professionals to develop a finished product that meets your exact specifications.

# P 合作伙伴

## Partners







◎ 制造工艺 / Manufacturing Process

那科牌钢格板严格执行产品质量标准，在ISO9001质量保证模式控制之下，确保其高品质，其制造工艺流程如下：

JUNKE steel gratings have been fabricated strictly in accordance to the product quality standards, and their high quality are guaranteed under the control of ISO 9001 quality system, The manufacturing process charts are.



◎ 纵剪扁钢机 Bearing Bar Making Machine

◎ 扭绞方钢机 Twisted Square Bars Machines

◎ 钢格板自控压焊机 PLC Press Welding Machines



◎ 压焊 Press Welding

◎ 移动式圆盘冷锯 Cutting Machine



◎ 全自动压阻焊机 PLC Press Welding Machines

◎ 切割 Cutting

◎ 焊接 Welding

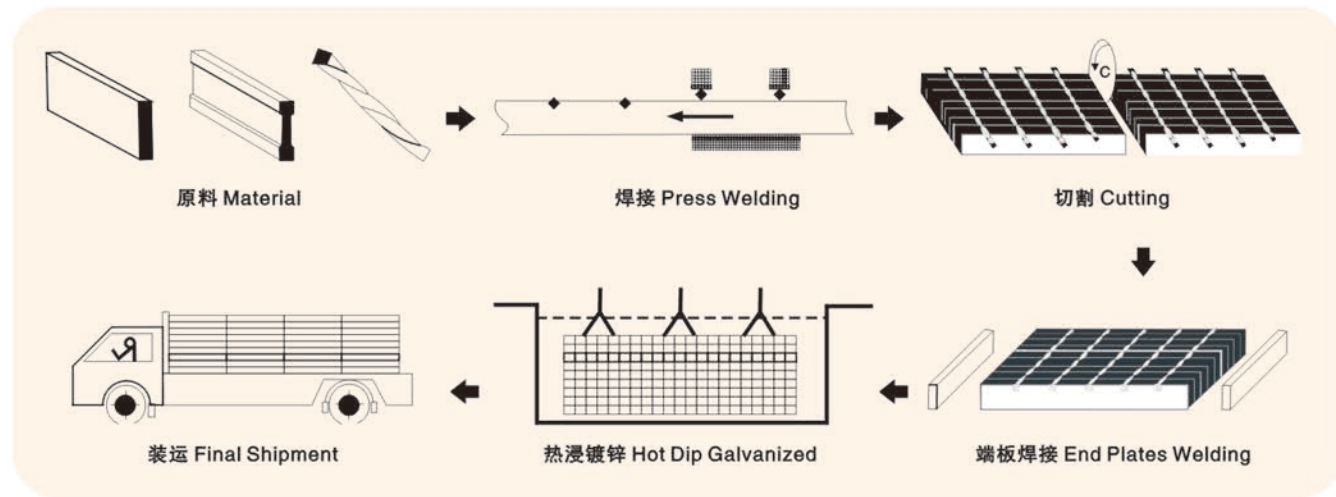

◎ 钢格板的质量标准/Quality Standard

钢格板标准Steel Grating Standards:

- ◎ 中国(CHINA): YB/T4001-2007
- ◎ 美国(U.S.A): ANSI/NAAMM ( MBG531-88 )
- ◎ 英国(U.K.): BS4592-1987
- ◎ 澳大利亚 ( A.U ): AS1657

钢材标准Steel Product Standards:

- ◎ 中国(CHINA): GB700-88
- ◎ 美国(U.S.A): ASTM(A36)
- ◎ 英国(U.K.): BS4360(43A)
- ◎ 澳大利亚 ( A.U ): AS3679

热浸锌标准Hot Galvanizing Standard:

- ◎ 中国(CHINA): GB/T13912
- ◎ 美国(U.S.A): ASTM(A123)
- ◎ 英国(U.K.): BS729
- ◎ 澳大利亚(A.U): AS1650

◎ 应用领域/Fields of Application

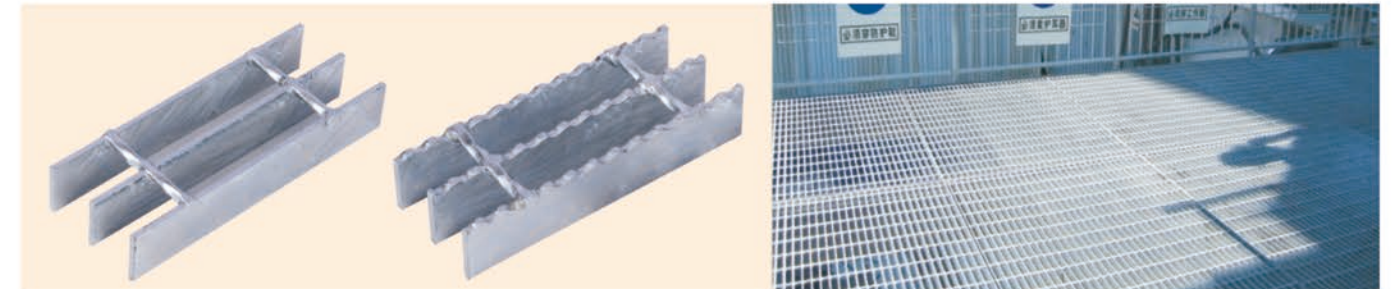

● 平面型 Plain Style

● 齿型 Serrated Style



◎ 具体用途/What It Is Used For

平台	Platforms	步行天桥	Sidewalks beside	海洋作业船	Ventilators
走道	Sidewalks	料机走道	Overline passage	通风窗	Fences
栈桥	Landing stages	球场围栅	Illumination	防盗门窗	Top stews for trucks
钻井平台	Drilling platforms	系留船坞	Machine frames and framework	围墙栅栏	Paint baking chambers
踏步板	Ladder steps	机场照明护栏	Safety doors and windows	设备人行道	Billboards
沟渠盖	Ditch grates	洗车场走道	Overline walking bridges	设备安全栏	Elevated pipeline corridors
排水井盖	Framed grates	广告牌	Landing stepways for ships	船用登踏板	Mooring docks
拦污栅	Trash rack grates	桥边走道	Safety Protection beside machines	货车顶部走道	Bridge sidewalks
仓库货架	Storage shelves	滤栅	Filter grates	铁道跨越走道	Stacker sidewalks
畜生围栏	Barnyard fences	通风栅栏	Ventilation grates	烤漆房	Equipment
脚手架	Scaffolding	机架和框架	Loading bridges	管廊栈桥	Way on the railway
洗涤架	Scrubbing frames	输送廊栈桥	Offshore barges	立体停车场	Fence on the aerodrome
遮阳架	Sunshade boxes				





◎ 钢格板规格型号/Steel Grating Specifications

Conforms to Specification RR-G-661

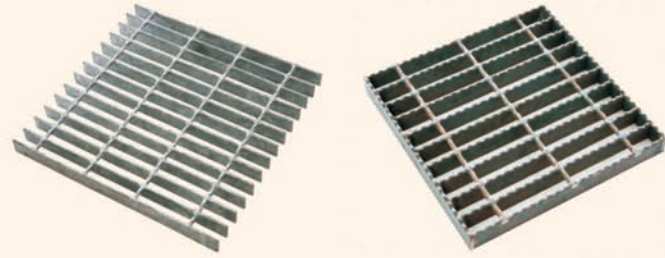

**平面型** Smooth Surface Grating  
**防滑齿型** Serrated Surface Safety Grating  
Grating available in Carbon steel, Aluminum, Stainless & Fiberglass

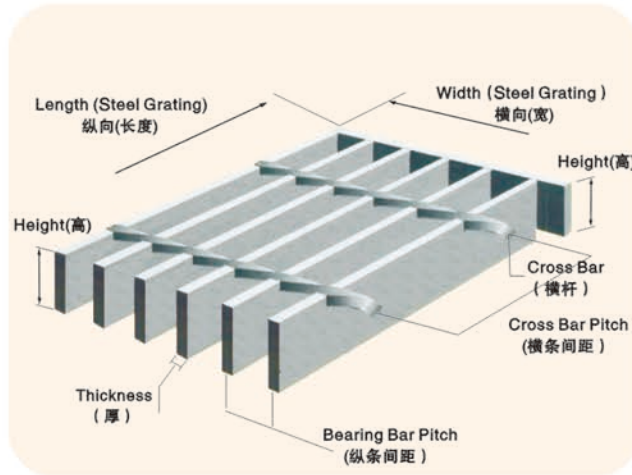

Lbs.Per Sq.Ft. 磅/平方英尺					
扁钢	规格	规格	规格	规格	
Bearing Bars	Type 19W4	Type 19W2	Type 15W4	Type 15W2	
3/4x	1/8	4.0	4.6	4.8	5.5
3/4x	3/16	5.6	6.3	6.9	7.5
1 x	1/8	5.1	5.7	6.2	6.9
1 x	3/16	7.3	8.0	9.0	9.6
1 1/4x	1/8	6.1	6.8	7.5	8.2
1 1/4x	3/16	8.9	9.6	11.1	11.7
1 1/2x	1/8	7.3	7.9	9.0	9.6
1 1/2x	3/16	10.6	11.2	13.1	13.8
1 3/4x	3/16	12.2	12.9	15.2	15.8
2 x	3/16	13.9	14.5	17.3	17.9
2 1/4x	3/16	15.4	16.1	19.2	19.9
2 1/2x	3/16	17.1	17.7	21.3	22.0

Stock sizes

板宽/英寸	panel width in inches	板长/英寸	panel length in inches
36		240.288	

其他扁钢大小和间距也是可以定做的所有钢格板都可以按照规格来产生。  
Other bearing bar sizes and spacings are available, all grating can be cut to your specification.

Pitch of Cross Bar

The centre distance between two cross bars adjacent to each other is called pitch of cross bar. Standard pitch is 100mm(pattern A)

横杆中心距

两支紧临扭方钢的中心距离称之为“横杆中心距”。标准一般为100mm

Pitch of Load Bar

The centre distance between two bearing bars adjacent to each other is called 'pitch of bearing bar'. Standard pitch is 30mm(series 30)

扁钢中心距

两支紧临扁钢的中心距离称之为“扁钢中心距”。标准一般为30mm

◆ 型号说明/Model Description

- 1) 承重扁钢型号: 20×3~100×10mm
  - 2) 承重扁钢间距: 12.5、25、30、30.16、32.5、34.3、38.1、40、42.5、60mm等等, 可以根据客户要求定做。
  - 3) 横杆间距: 38、50、76、100mm等等, 也可以根据客户要求定做。
  - 4) 材质: 低碳钢或者不锈钢
  - 5) 表面处理: 无处理, 喷漆或者热浸锌
- 1) Bearing Bar Specification: 20×3 to 100×10mm
  - 2) Bearing Bar Pitch: 12.5、30、30.16、32.5、34.3、38.1、40、42.5、60mm etc, also be according to client's requirement and 30,40,60mm are recommended
  - 3) Cross Bar Pitch: 38,50,76,100mm etc, also be according to client's requirement and 50,100mm are recommended
  - 4) Material: Mild Steel or Stainless Steel
  - 5) Surface Treatment: Untreated, Painting or Hot Dip Galvanizing

◆ 型号分类/Model Classification

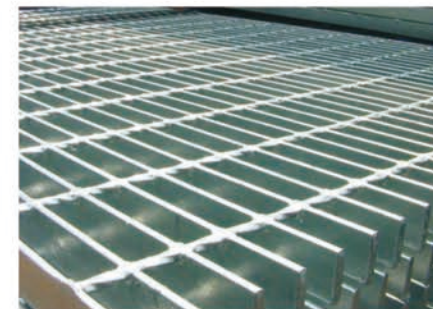

平面型钢格板 Plain Steel Grating

**平面型:** 平面型钢格板是应用最广泛的钢格板之一, 主要用于平台、走道、沟盖板、踏步板等。

**Plain:** One of the most widely used gratings, available for flooring, sidewalk, drainage pit cover, stair tread, etc.

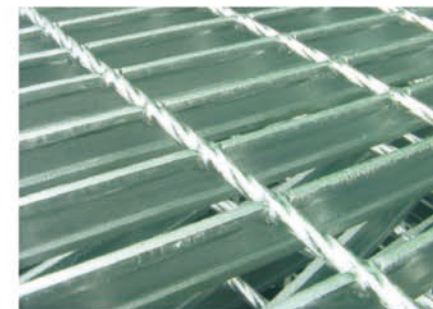

I型钢格板 I Bar Steel Grating

**I型:** 与平面型钢格板相比, I型钢格板最具有重量轻, 更加经济适用等特点。

**I-shape:** Lighter, more economical and practical comparing with plain grating.

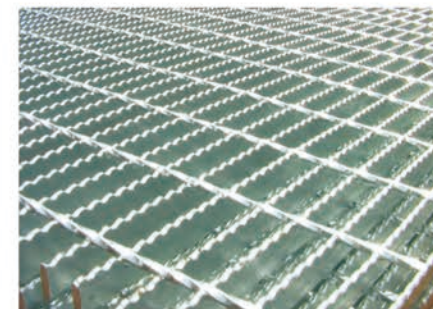

齿型钢格板 Serrated Steel Grating

**齿型:** 与平面型钢格板相比, 齿型钢格板的防滑效果最好。

**Serrated:** Better non-skid property & safety comparing with plain grating.

标准型

STANDARD MESH TYPES

TYPE 19W4 TYPE 19W2

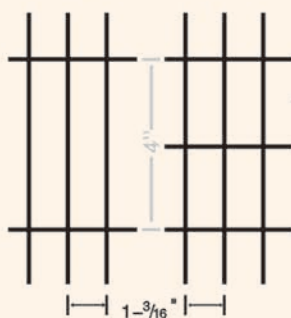

紧密型

CLOSE MESH TYPES

TYPE 15W4 TYPE 15W2

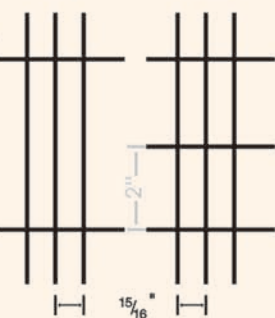

扁钢

Bearing Bars Center to Center

中间距横杆

Cross Bars Center to Center





# SIGN OF STEEL GRATING

## 钢格板型号标记

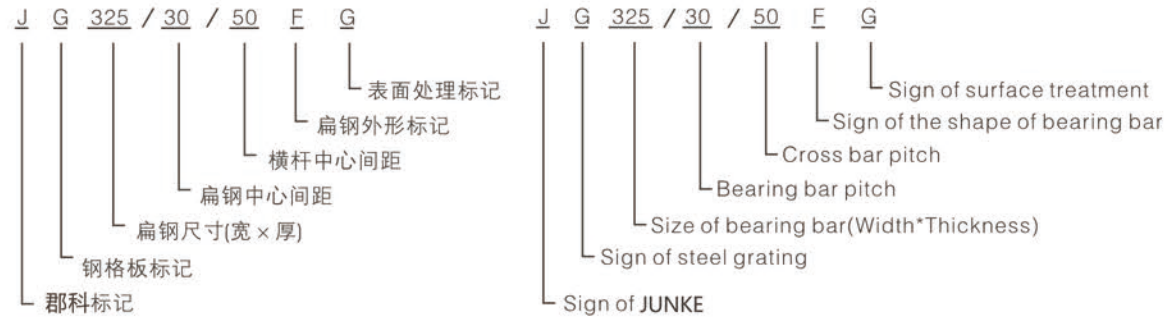

1、扁钢中心间距有12.5、15、20、22、23.85、25、30、30.16、30.3、32.5、34.3、35、35.3、40、41、41.4、60mm等。

2、横杆中心间距有38、50、60、76、100mm，推荐采用50mm、100mm。

3、扁钢外形标记：  
F 表示平面型扁钢(在标记中可省略)；  
S 表示齿型扁钢；  
I 表示工字型扁钢；

4、表面处理状态标记：  
G 表示热浸镀锌(在标记中可省略)；  
P 表示涂漆；  
U 表示表面不作处理。

1.Bearing bar pitches may be 12.5, 15, 20, 22, 23.85, 25, 30, 30.16, 30.3, 32.5, 34.3, 35, 35.3, 40, 41, 41.4, 60mm.

2.Cross bar pitches may be 38,50,60, to 100mm, of which 50mm & 100mm are recommended.

3.Sign of the shape of bearing bars.  
F - Plain style (may be omitted in the symbol of steel grating)  
S - Serrated style  
I - I-shape style

4.Sign of surface treatment  
G - Hot-dip galvanizing (may be omitted in the symbol of steel grating)  
P - Painted  
U - Untreated

# MATERIAL / 材料

1. 扁钢和横杆均采用GB/T700的Q235制造，根据供需双方协议，也可采用其他材料制造。

Bearing bar & cross bar are Q235 standard which's in line with GB/T700. Other materials can also be used according to customer.

2. 扁钢采用热轧扁钢或经过纵剪的热轧或冷轧钢带。

Hot-rolled flat bar, hot-rolled strip or cold-rolled strip silt by slitting shears are available for bearing bar.

3. 扁钢尺寸允许偏差符合表一 YB/T4001.1-2007的规定。

Tolerance for the size of hot-rolled flat bar should be in accordance with the standard of YB/T4001.1-2007.

表1 扁钢尺寸允许偏差( Tolerance of bearing bar size) 单位为毫米

公称尺寸(Nominal Size)	允许偏差 (Tolerance)
厚度(Thickness)	3~16
	+0.2 -0.4
	10~50
	+0.3 -0.9
	>50~75
	+0.4 -1.2
	>75~100
	+0.7 -1.7
	>100~150
	+0.8 -1.8

4. 齿型扁钢采用热轧扁钢或经过纵剪和冲齿的热轧或冷轧钢带。齿型尺寸如图1所示，在每100mm内不能少于5齿。

Serrated bars are usually hot rolled flat bar with serration or puching the serration on hot rolled strip or cold-rolled strip. The serration pattern see picture 1. There are min 5 teeth within 100mm length.

5.工字型扁钢的截面尺寸及截面惯性矩符合图2和表2的要求。

The size of I section & processional moment of section should be in accordance with the following requirements.

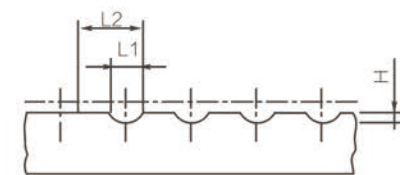

$L1 \geq 0.55 L2$   
 $1.5mm \leq H < 2.5mm$



图1 齿型尺寸 (Serrated bar size)

图2 工字型扁钢的截面尺寸 (Section size of I-shape bearing bar)

表2 工字型扁钢的截面尺寸及特性 (Section sizes & features of I-bar) 单位为毫米 (In mm)

型钢宽度H Steel bar height		翼缘厚度A Width of flange		腹板厚度 B Thickness of flank		腹板宽度C Width of flank		翼缘宽度d		截面抵抗矩W cm <sup>3</sup>	截面惯性矩 I processional moment of section cm <sup>4</sup>	理论重量 Nom.Weight
公称尺寸 Nominal Size	允许偏差 Tolerance	公称尺寸 Nominal Size	允许偏差 Tolerance	公称尺寸 Nominal Size	允许偏差 Tolerance	公称尺寸 Nominal Size	允许偏差 Tolerance	公称尺寸 Nominal Size	允许偏差 Tolerance			
25						14	4.5			0.48	0.6	0.75
32						18	6			0.78	1.25	0.96
38	±0.4	5	±0.3	3		22	7			1.1	2.08	1.13
44						26	8			1.46	3.22	1.3
50						31	8.5		±0.5	1.84	4.61	1.46
50						31	8			2.57	6.43	1.98
55						35	8.5			3.09	8.49	2.16
60	±0.5	7	±0.4	4		37	10			3.72	11.22	2.39
65						42	10			4.29	13.96	2.55
75						48	12			5.7	21.39	2.96

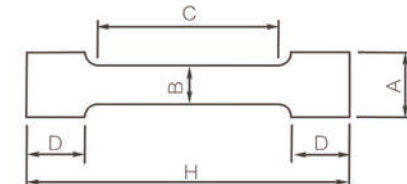

## INSTALLATION OF STEEL GRATING

### 钢格板安装方法

1、钢格板的安装可用焊接和安装夹两种方法。焊接固定适用于永久不需拆卸的部位，如设备周围平台。而采用安装夹具有不破坏锌层及拆卸方便的特点。

Using fixing clips will be much easier to install and uninstall without destroying the zinc coating. The welding suitable for those places where there is no need to move or dismantling, for instance, the plat form machine.

2、焊接固定的方法是：在钢格板每个角第一根扁钢上，焊缝长不小于20mm，高不小于3mm的角焊。

Regarding welding fixing, angle welding would be used at the first bearing bar of every corner, which the welding length is no less than 20mm, & the height is no less than 3mm.

3、安装夹适用于各种系列的钢格板，由上卡、下卡和M8螺栓组成。

Saddle clips are suitable for all kinds of steel gratings, composed of a top saddle, a bottom saddle & a M8 bolt.

4、采用安装夹固定的方法是：每块板至少采用四套安装夹，对跨距较大的板块最好在可利用的支撑物上多安装几个。在订购安装夹时，请注明所需夹子的型号和数量。

Regarding using clip, four sets of clips would be used at least in one m<sub>2</sub> grating. It would be better to use more in the staddle for thoes gratings with bigger span.

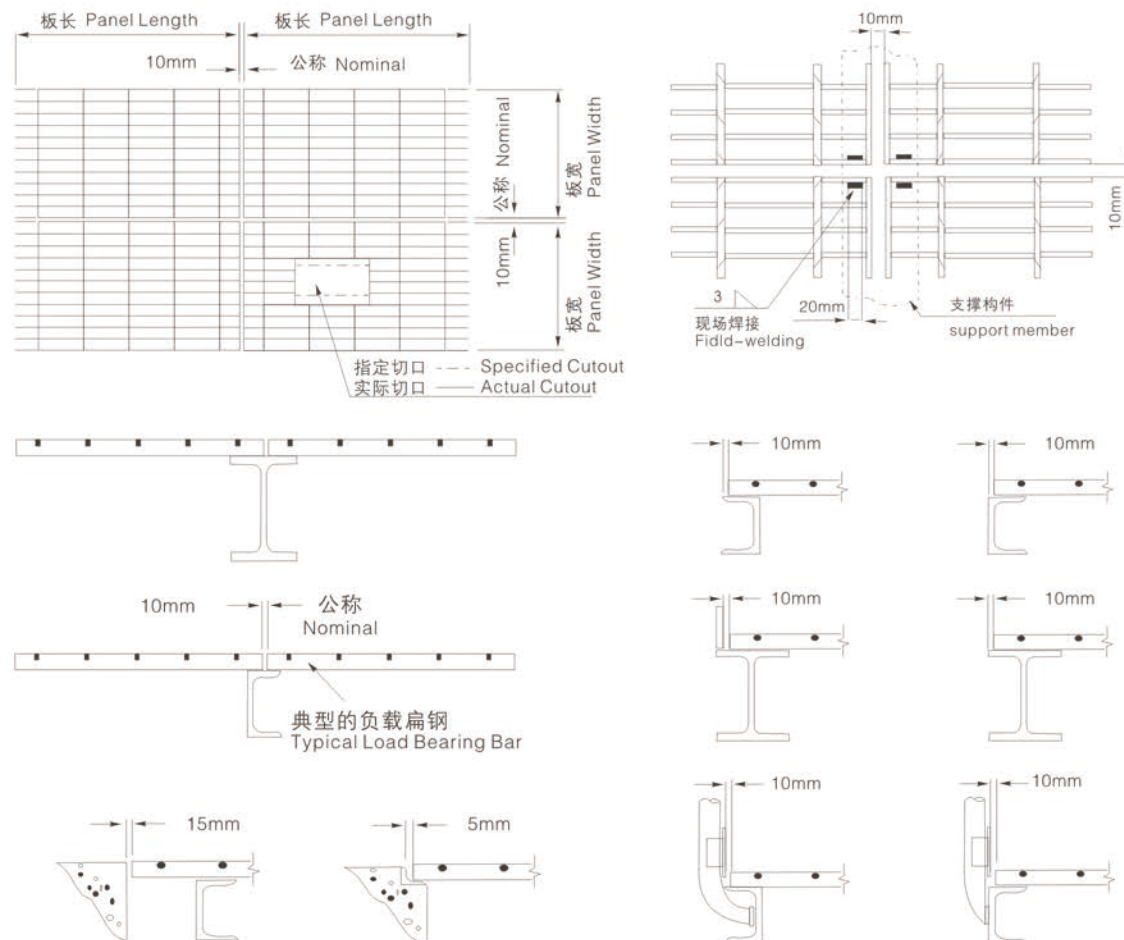

## SADDLE CLIPS FASTENING METHOD / 安装夹



• A型(Type A)



• B型(Type B)



• C型(Type C)

A型：由一块带双钩的上压板，一块带齿的下压板及一个M8的内六角螺栓组成。

B型：由一块带双钩的上压板(其中一个钩可将相邻的两块钢格板连接在一起)，一块带齿的下压板 and 一支M8的内六角螺栓组成。

C型：由一块带双钩的上压板和一个可焊接在支撑构件上的M8的内六角螺栓组成。

Type A: composed of a top saddle a bottom saddle and M8 bolt.

Type B: composed of a top saddle a hook shaped bottom saddle and M8 bolt.

Type C: composed of a top saddle which can be welded to supporting structure and M8 bolt.

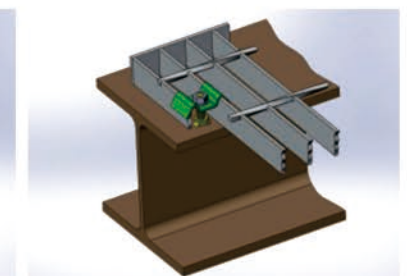
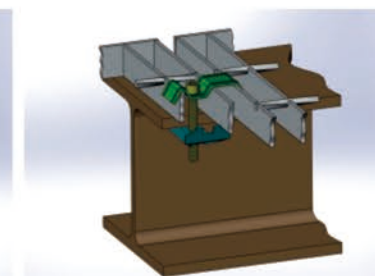
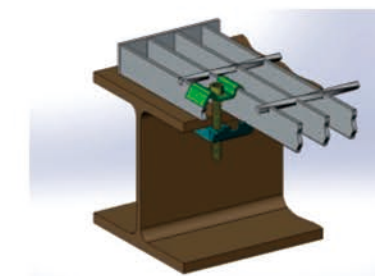

安装夹型号 Type of Saddle Clips			适用钢格板型号 Applicable for Steel Grating
A-30	B-30	C-30	扁钢中心间距(Bearing bar pitch) 30mm
A-40	B-40	C-40	扁钢中心间距(Bearing bar pitch) 40mm
A-60	B-60	C-60	扁钢中心间距(Bearing bar pitch) 60mm



## SURFACE TREATMENT

### 钢格板表面处理

对钢格板的表面处理，可采用热浸锌、涂漆或采用其他防腐涂层的处理方法。推荐采用热浸锌处理。

Regarding surface treatment, hot-dip galvanizing, paint or using other anti-corrosive paint are available.

## NONCORROSIBILITY OF HOT-DIP GALVANIZING

### 热浸锌的防腐性能

1. 锌层厚度100um的钢格板在各种环境中的预计使用寿命为：

The anticipated useful time of grating with the thickness of 100um hot-dip galvanizing coating is as follow.

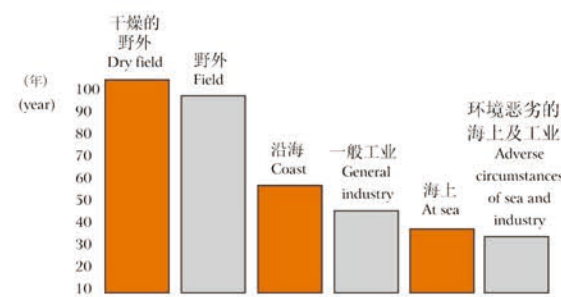

2. 防酸碱腐蚀能力：钢格板在PH6至PH12.5的范围内，锌层表面形成稳定的保护膜，耐磨腐蚀性能好。

Within the environmental arrange from PH6 to PH12.5, the protective layer will be formed on the zinc coat, with good corrosion resistance.

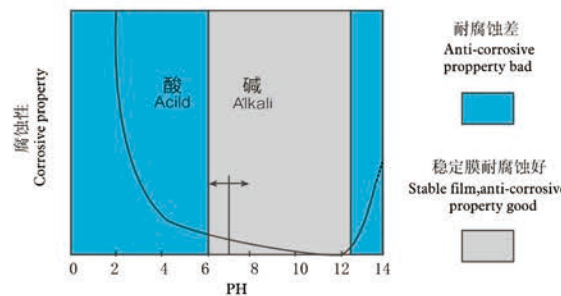

## AREA CALCULATION

### 钢格板面积计算

1、在没有图纸，按用户提供尺寸加工的，面积为实际交付钢格板数量乘以长度和宽度的总和，它包含开孔和切口部分。

2、提供图纸代为用户进行钢格板平面布置设计的，面积按图纸上总的外围尺寸计算，它包含开孔和切口部分。

3、对异型钢格板，面积按全部块数的长(L) × 宽(W) 计算，不扣除切口部分。

1. When drawings not provided but the dimension offered by customers, the area shall refer the quantity of grating actually delivered multiplied by the sum of length and width, including trepannings and cutouts.

2. In case we offer drawings and design the layout sketch of grating for customers, the area should be calculated according to total external dimension in plans, including trepannings and cutouts.

3. Regarding special shaped gratings, the total area should be calculated based on all the pieces (length (L) times width(W) )furnished, with no deduction for cutouts

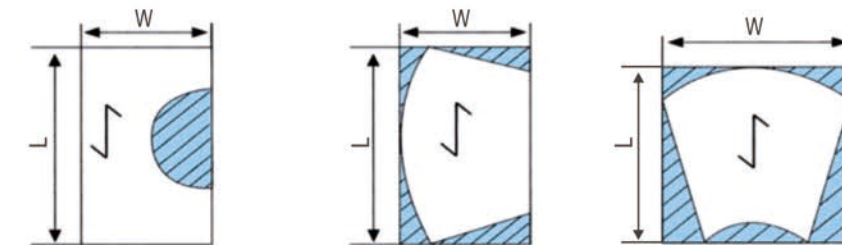
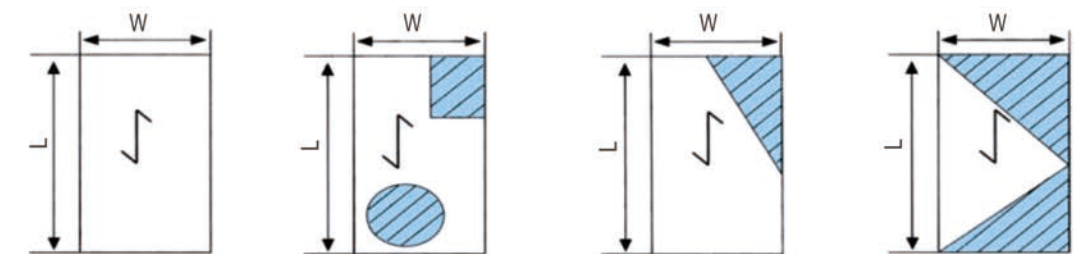

 : 切口 Cutout  
 L: 长度 Length  
 W: 宽度 Width  
 负载扁钢方向 Flat Bar Direction





◆常用钢格板扁钢条数与公称宽度表  
Relation Between Nominal Width Of Panel And Number  
of Bearing Bars For Most-popular Steel Gratings

扁钢条数 Number of Bearing Bars	公称宽度 (mm) Nominal Width		
	扁钢中心距 (30mm) Bearing Bar Centers	扁钢中心距 (40mm) Bearing Bar Centers	扁钢中心距 (60mm) Bearing Bar Centers
5	125	165	245
6	156	205	305
7	185	245	365
8	215	285	425
9	245	325	485
10	275	365	545
11	305	405	605
12	335	445	665
13	365	485	725
14	395	525	785
15	425	565	845
16	455	605	905
17	485	645	965
18	515	685	1025
19	545	725	1085
20	575	765	1145
21	605	805	
22	635	845	
23	665	885	
24	695	925	
25	725	1005	
26	755	1045	
27	785	1085	
28	815	1125	
29	845	1165	
30	875		
31	905		
32	935		
33	965		
34	995		
35	1025		
36	1055		
37	1085		
38	1115		
39	1145		
40	1175		

注：  
表中的钢格板宽度是按扁钢厚度5mm计算的。如果厚度为3mm，则减去2mm，由于扁钢存在偏差，以及加工过程中的原因，实际宽度略有变化。

Note:  
The widths in the table are calculated to the bearing bar thickness of 5mm. When the bearing bar thickness of 3mm is Used, the widths in the table should be reduced by 2mm. The actual widths would slightly vary owing to the tolerance of raw materials and processing.

◆安全载荷与跨距及变形挠度数据说明

表中U表示安全外加均布荷载，KN/m<sup>2</sup>，  
表中C表示宽度方向的安全外加线荷载，KN/m，  
表中D表示变形挠度，mm，  
表中粗实线左边各种间距相应的挠度，在均布面荷载为5.0KN/m<sup>2</sup>的设计荷载下，均满足跨度的1/200或不大于10mm；  
钢格板自重是指含包边及表面处理后的重量。

◆Data Notes For Table of Relation Among Safeload, Span And Deflection

U=safe uniformly distributed load in KN/m<sup>2</sup>;  
C=safe concentrated load in KN/m width at mid span  
D=deflection in mm  
Grating for spans to the left of the thick line in table have a deflection of less than 10mm or 1/200th of span for uniform load of 5.0KN/m<sup>2</sup>  
Grating self-weight is the weight after welding end plate, toe plate and surface treatment.

◆扁钢中心间距为30mm 压焊钢格板 常用规格及安全荷载表  
30mm Pitch Press Welded Steel Grating Common Specification & Safety  
Loading Table

型号 Specification	扁钢 宽度 (mm) Bearing Bar Width	扁钢 厚度 (mm) Bearing Bar Thickness	理论 重量 (kg/m <sup>2</sup> ) Weight	跨距(mm) Clear Span															
				200	400	600	800	1000	1200	1400	1600	1800	2000	2200	2400	2600	2800	3000	
G655/30/50W	65	5	103.4	U	3990	997	443	249	159	110	81	62	49	39	32	27	23	20	17
				D	0.11	0.42	0.95	1.7	2.65	3.81	5.22	6.84	8.7	10.61	12.82	15.4	18.18	21.4	24.18
				C	399	199	133	99	79	66	57	49	44	39	36	33	30	28	26
G655/30/100W	65	5	100.4	U	3400	850	377	212	136	94	69	53	41	34	28	23	20	17	
				D	0.11	0.46	1.03	1.84	2.89	4.15	5.66	7.45	9.28	11.78	14.28	16.73	20.16	23.23	
				C	340	170	113	85	68	56	48	42	37	34	30	28	26	24	
G605/30/50W	60	5	95.9	U	2856	714	317	178	114	79	58	44	35	28	23	19	16		
				D	0.13	0.5	1.13	2	3.14	4.53	6.19	8.04	10.3	12.63	15.29	18.03	21.08		
				C	285	142	95	71	57	47	40	35	31	28	25	23	21		
G605/30/100W	60	5	92.9	U	2361	590	262	147	94	65	48	36	29	23	19	16			
				D	0.14	0.55	1.24	2.2	3.45	4.97	6.82	8.78	11.39	13.86	16.88	20.28			
				C	236	118	78	59	47	39	33	29	26	23	21	19			
G555/30/50W	55	5	88.4	U	1416	354	157	88	56	39	28	22	17	14	11				
				D	0.14	0.55	1.24	2.2	3.43	4.97	6.65	8.95	11.16	14.09	16.37				
				C	141	70	47	35	28	23	20	17	15	14	12				
G555/30/100W	55	5	85.4	U	1156	289	128	72	46	32	23	18	14	11					
				D	0.11	0.44	0.99	1.75	2.75	3.92	5.45	6.97	8.82	11.37	13.14				
				C	115	57	38	28	23	19	16	14	12						
G505/30/50W	50	5	80.9	U	967	241	107	60	38	26	19	15	11						
				D	0.15	0.61	1.38	2.45	3.83	5.56	7.62	9.73	12.44	15.76	18.39				
				C	191	95	63	47	38	31	27	23	21	19	17				
G505/30/100W	50	5	77.9	U	815	204	90	51	32	22	16	12	9	7	6				
				D	0.12	0.49	1.09	1.94	3.07	4.35	6.06	7.76	10.16	12.72	15.31				
				C	151	75	50	37	30	25	21	18	16	15					
G455/30/50W	45	5	73.4	U	694	173	77	43	27	19	14	10							
				D	0.15	0.61	1.38	2.45	3.83	5.56	7.62	9.73	12.44	15.76	18.39				
				C	191	95	63	47	38	31	27	23	21	19	17				
G455/30/100W	45	5	70.4	U	580	145	64	36	23	16	11	9	7	6					
				D	0.17	0.69	1.54	2.76	4.31	6.14	8.37	11.02	13.92	17.8					
				C	151	75	50	37	30	25	21	18	16	15					
G405/30/50W	40	5	65.9	U	490	122	53	30	19	13	9	7	6						
				D	0.14	0.55	1.23	2.17	3.46	5.01	6.73	8.69	11.1	14.39					
				C	151	75	50	37	30	25	21	18	16	15					
G405/30/100W	40	5	62.9	U	406	101	44	25	16	11	8	6	5						
				D	0.17	0.69	1.54	2.74	4.32	6.25	8.39	11.2	14.21						
				C	90	45	30	22	18	15	12	11	10						
G355/30/50W	35	5	58.4	U	335	83	36	20	13	9	7	6							
				D	0.14	0.55	1.24	2.16	3.46	5.02	6.44	8.87	11.59						
				C	90	45	30	22	18	15	12	11	10						
G355/30/100W	35	5	55.4	U	289	72	31	18	11	8	6	5							
				D	0.16	0.62	1.4	2.46	3.97	5.7	7.69	10.14	12.52						
				C	90	45	30	22	18	15	12	11	10						
G325/30/50W	32	5	53.9	U	241	60	26	15	9	7	6								
				D	0.22	0.86	1.94	3.44	5.35	7.64	10.42	14.13	16.81						
				C	96	48	32	24	19	16	13	12	10						
G325/30/100W	32	5	50.9	U	197	49	22	13	8	6	5								
				D	0.17	0.68	1.55	2.76	4.3	6.3	8.21	11.4	13.73						
				C	58	29	19	14	11	9	8	7							
G323/30/50W	32	3	35.8	U	156	39	17	10	6	4	3	2	2						
				D	0.21	0.86	1.93	3.45	5.41	7.85	10.09	14.19							
				C	58	29	19	14	11	9	8	7							
G323/30/100W	32	3	32.8	U	122	30	13	8	5	4	3	2	2						
				D	0.17	0.69	1.53	2.69	4.16	5.93	8.44	11.15							
				C	58	29	19	14	11	9	8	7							
G255/30/50W	25	5	43.4	U	967	241	107	60	38	26	19	15	11						
				D	0.28	1.1	2.47	4.35	6.82	9.92	13.9								
				C	59	29	19	14	11	9	8								
G255/30/100W	25	5	40.4	U	815	204	90	51	32	22	16	12	9	7					
				D	0.22	0.87	1.93	3.39	5.25	7.5	10.71								
				C	59	29	19	14	11	9	8								
G253/30/50W	25	3	29.3	U	354	88	39	22	14	9	7	6							
				D	0.28	1.1	2.47	4.43	6.84	9.35									
				C	35	17	11	8	7	5									
G253/30/100W	25	3	26.3	U	277	69	30	17	10	7	6								
				D	0.22	0.85	1.86	3.24	5.58	7									
				C	35	17	11	8	7	5									
G205/30/50W	20	5	36.0	U	377	94	41	23	15	10									
				D	0.34	1.37	3.05	5.44	8.73	12.21									
				C	37	18	12	9	7	6									
G205/30/100W	20	5	33.0	U	226	56	25	14	9	7	6								
				D	0.27	1.05	2.39	4.28	6.57	9.85									
				C	22	11	7	5	4										
G203/30/50W	20	3	24.6	U	226	56	25	14	9	7	6								
				D	0.34	1.37	3.1	5.53	8.76										
				C	22	11	7	5	4										
G203/30/100W	20	3	21.6	U	185	46	20	11	7	5	4								
				D	0.27	1.07	2.32	3.98	6.3										
				C	22	11	7	5	4										

说明：  
1. U表示钢格板安全外加均布荷载，kN/m<sup>2</sup>；  
2. C表示钢格板跨度中心线上垂直于承载扁钢方向的安全外加线荷载，kN/m  
3. D表示钢格板在所列安全外加荷载作用下的最大挠度，mm；  
4. 列出数据区域表示钢格板在2kN/m<sup>2</sup>的均布荷载作用下，最大挠度小于4mm；  
5. 理论重量表示热镀锌钢格板长度为1m时的重量。





扁钢中心间距为40mm 压焊钢格板 常用规格及安全荷载表
40mm Pitch Press Welded Steel Grating Common Specification & Safety Loading Table

I型扁钢中心间距为30mm 压焊钢格板 常用规格及安全荷载表
30mm Pitch I Bar Grating Common Specification & Safety Loading Table

Table with columns: 型号 Specification, 扁钢宽度 (mm) Bearing Bar Width, 扁钢厚度 (mm) Bearing Bar Thickness, 理论重量 (kg/m²) Weight, 跨距 (mm) Clear Span (200-3000), and rows for various grating specifications (G655/40/50W to G203/40/100W).

说明:
1. U表示钢格板安全外加均布荷载, kN/m²;
2. C表示钢格板跨度中心线上垂直于承载扁钢方向的安全外加线荷载, kN/m
3. D表示钢格板在所列安全外加荷载作用下的最大挠度, mm;
4. 列出数据区域表示钢格板在2kN/m²的均布荷载作用下, 最大挠度小于4mm;
5. 理论重量表示热镀锌钢格板长度为1m时的重量。

Table with columns: 型号 Specification, 型钢宽度 (mm) Steel width, 翼缘厚度 (mm) Flange Thickness, 腹板宽度 (mm) Abdominal Width, 翼缘宽度 (mm) Flange Width, 理论重量 (kg/m²) Weight, 跨距 (mm) Clear span (200-3000), and rows for various I-bar grating specifications (G757/30/50WI to G255/30/100WI).

说明:
1.U表示钢格板安全外加均布荷载, kN/m²;
2.C表示钢格板跨度中心线上垂直于承载扁钢方向的安全外加线荷载, kN/m
3.D表示钢格板在所列安全外加荷载作用下的最大挠度, mm;
4.列出数据区域表示钢格板在2kN/m²的均布荷载作用下, 最大挠度小于4mm;
5.理论重量表示热镀锌钢格板长度为1m时的重量。





◆ I型扁钢中心间距为40mm 压焊钢格板 常用规格及安全荷载表  
40mm Pitch I Bar Grating Common Specification & Safety Loading Table

型号 Specification	型钢 宽度 (mm) Steel Width	扁钢 厚度 (mm) Flange Thickness	扁钢 宽度 (mm) Flange Width	扁钢 高度 (mm) Flange Width	理论 重量 (kg/m <sup>2</sup> ) Weight	跨距(mm) Clear span															
						200	400	600	800	1000	1200	1400	1600	1800	2000	2200	2400	2600	2800	3000	
G757/40/50WI	75	7	4	12	101	U	4845	1211	538	302	193	134	98	75	75	59	48	40	33	28	24
						D	0.09	0.37	0.83	1.47	2.29	3.31	4.49	5.89	5.89	7.44	9.27	11.35	13.33	15.66	18.16
G757/40/100WI	75	7	4	12	95.6	C	484	242	161	121	96	80	69	60	60	53	48	44	40	37	34
						D	0.07	0.29	0.66	1.18	1.83	2.64	3.63	4.72	4.72	5.97	7.45	9.13	10.85	12.83	14.83
G657/40/50WI	65	7	4	10	88.5	U	3646	911	405	227	145	101	74	56	56	45	36	30	25	21	18
						D	0.11	0.42	0.95	1.69	2.64	3.83	5.21	6.75	6.75	8.72	10.88	13.1	15.54	18.1	21
G657/40/100WI	65	7	4	10	83.2	C	364	182	121	91	72	60	52	45	45	40	36	33	30	28	26
						D	0.08	0.34	0.76	1.36	2.1	3.04	4.2	5.44	5.44	6.92	8.6	10.55	12.54	14.98	17.5
G607/40/50WI	60	7	4	10	78.9	U	3162	790	351	197	126	87	64	49	49	39	31	26	21	18	16
						D	0.11	0.46	1.03	1.83	2.86	4.1	5.61	7.35	7.35	9.41	11.46	14.13	16.28	19.33	23.23
G607/40/100WI	60	7	4	10	75.9	C	316	158	105	79	63	52	45	39	35	31	28	26	24	22	
						D	0.09	0.37	0.82	1.47	2.29	3.28	4.52	5.87	5.87	7.54	9.22	11.16	13.54	16	18.48
G557/40/50WI	55	7	4	8.5	71.9	U	2626	656	291	164	105	72	53	41	41	32	26	21	18	15	
						D	0.13	0.5	1.13	2.01	3.15	4.49	6.14	8.14	8.14	10.22	12.72	15.14	18.48	21.37	
G557/40/100WI	55	7	4	8.5	68.9	C	262	131	87	65	52	43	37	32	29	26	23	21	20		
						D	0.1	0.4	0.9	1.59	2.5	3.58	4.92	6.38	6.38	8.28	10.25	12.16	14.53	17.71	
G507/40/50WI	50	7	4	8	66.4	U	2184	546	242	136	87	60	44	34	34	26	21	18	15		
						D	0.14	0.55	1.24	2.2	3.45	4.95	6.74	8.93	8.93	11	13.62	17.18	20.42		
G507/40/100WI	50	7	4	8	63.4	C	218	109	72	54	43	36	31	27	24	21	19	18			
						D	0.11	0.44	0.98	1.75	2.73	3.97	5.45	7.13	7.13	9.07	10.98	13.33	16.5		
G505/40/50WI	50	5	3	8.5	50.4	U	1564	391	173	97	62	43	31	24	24	19	15	12			
						D	0.14	0.55	1.23	2.19	3.43	4.95	6.64	8.8	8.8	11.22	13.6	16.05			
G505/40/100WI	50	5	3	8.5	47.4	C	156	78	52	39	31	26	22	19	19	17	15	14			
						D	0.11	0.44	0.99	1.76	2.75	4	5.4	7.01	7.01	8.98	10.96	13.72			
G445/40/50WI	44	5	3	8	45.5	U	1241	310	137	77	49	34	25	19	19	15	12				
						D	0.16	0.62	1.4	2.49	3.88	5.61	7.68	10.01	10.01	12.73	15.64				
G445/40/100WI	44	5	3	8	42.5	C	124	62	41	31	24	20	17	15	13	12					
						D	0.12	0.5	1.12	2.01	3.05	4.41	5.99	7.95	7.95	9.89	12.62				
G385/40/50WI	38	5	3	7	40.3	U	935	233	103	58	37	25	19	14	14	11					
						D	0.18	0.73	1.63	2.91	4.55	6.4	9.06	11.47	11.47	14.54					
G385/40/100WI	38	5	3	7	37.3	C	93	46	31	23	18	15	13	11	11	10					
						D	0.14	0.57	1.31	2.31	3.55	5.14	7.12	9.08	9.08	11.85					
G325/40/50WI	32	5	3	6	35.1	U	663	165	73	41	26	18	13	10	10						
						D	0.21	0.86	1.92	3.43	5.33	7.69	10.37	13.71	13.71						
G325/40/100WI	32	5	3	6	32.1	C	66	33	22	16	13	11	9	8	8						
						D	0.17	0.69	1.55	2.68	4.28	6.3	8.26	11.06	11.06						
G255/40/50WI	25	5	3	4.5	28.7	U	408	102	45	25	16	11	8								
						D	0.28	1.1	2.47	4.36	6.86	9.86	13.41								
G255/40/100WI	25	5	3	4.5	25.8	C	40	20	13	10	8	6	5								
						D	0.22	0.87	1.91	3.5	5.51	7.24	9.71								

说明:

1. U表示钢格板安全外加均布荷载, kN/m<sup>2</sup>;
2. C表示钢格板跨度中心线上垂直于承载扁钢方向的安全外加线荷载, kN/m
3. D表示钢格板在所列安全外加荷载作用下的最大挠度, mm;
4. 列出数据区域表示钢格板在2kN/m<sup>2</sup>的均布荷载作用下, 最大挠度小于4mm;
5. 理论重量表示热镀锌钢格板长度为1m时的重量。

◆ 沟盖板规格表/Drainage Trench Cover

排水沟宽 Trench Width (mm)	沟盖板型号 Type of Pit Cover	钢格板型号 Grating Type	钢格板尺寸 Grating Size 长X宽(mm) LengthXWidth	边框尺寸 Frame Size (mm)	角钢规格(mm) Angle Steel Specification 边长X边长X厚度(mm) SideXSideXThickness
200	G20/I	G255/30/76	250X995	270	30X30X4
	G20/II	G305/30/76	260X995	280	36X36X5
300	G30/I	G305/30/76	360X995	380	36X36X5
	G30/II	G405/30/76	380X995	400	45X45X5
350	G35/I	G325/30/76	410X995	430	36X36X5
	G35/II	G405/30/76	430X995	450	45X45X5
400	G40/I	G405/30/76	480X995	500	45X45X5
	G40/II	G455/30/76	490X995	510	50X50X5
500	G50/I	G455/30/76	590X995	610	50X50X5
	G50/II	G505/30/76	600X995	620	56X56X5
600	G60/I	G505/30/76	700X995	720	56X56X5
	G60/II	G555/30/76	715X995	733	63X63X5

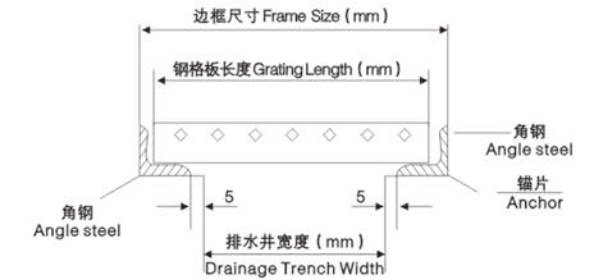
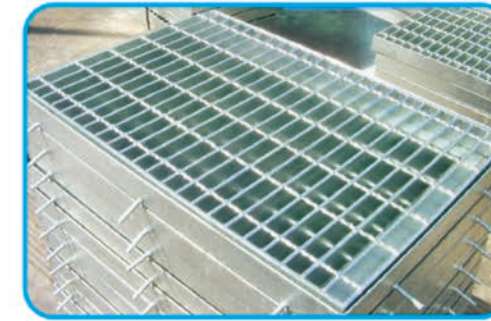

◆ U型排水沟盖规格表/U-type Trench Cover

排水沟宽 Trench Width (mm)	沟盖板型号 Type of Pit Cover	钢格板型号 Grating Type	钢格板尺寸 Grating Size 长X宽(mm) LengthXWidth	角钢规格(mm) Angle Steel Specification 边长X边长X厚度(mm) SideXSideXThickness	成品尺寸(A) Finished Product Size(mm)
200	G20/I/U	G255/30/76	180X995	40X40X5	260
	G20/II/U	G305/30/76	180X995	40X40X5	260
300	G30/I/U	G305/30/76	280X995	40X40X5	360
	G30/II/U	G405/30/76	280X995	40X40X5	360
350	G35/I/U	G325/30/76	330X995	40X40X5	410
	G35/II/U	G405/30/76	330X995	40X40X5	410
400	G40/I/U	G405/30/76	380X995	40X40X5	460
	G40/II/U	G455/30/76	380X995	45X45X5	470
500	G50/I/U	G455/30/76	478X995	45X45X5	568
	G50/II/U	G505/30/76	478X995	50X50X5	578
600	G60/I/U	G505/30/76	578X995	50X50X6	678
	G60/II/U	G555/30/76	574X995	56X56X8	686

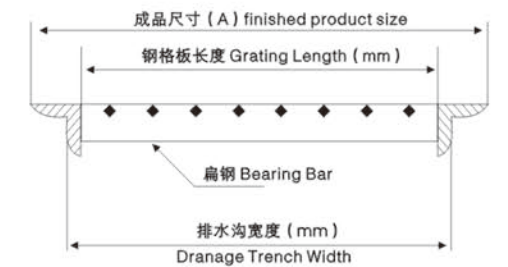
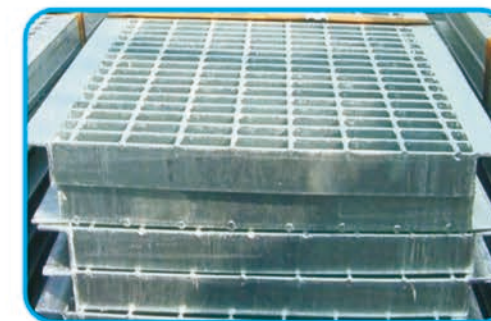





◆ 楼梯踏步板/Stair Treads

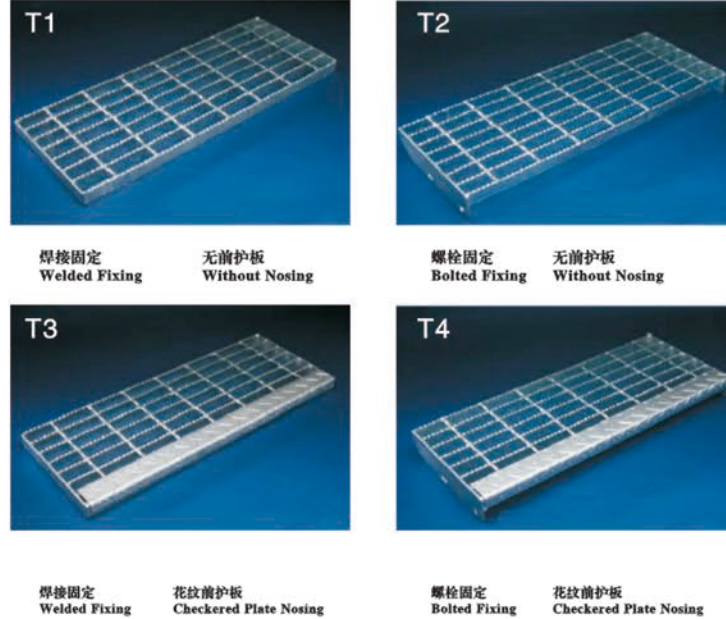

◆ 踏步板公差/Stair Tread Tolerance

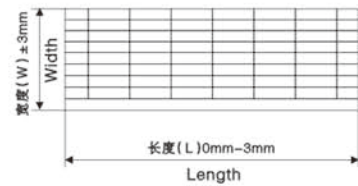

注意：踏步板的长度指两边包边扁钢外端面间的距离  
 Note: Length is the distance of both out-side welding end plates.

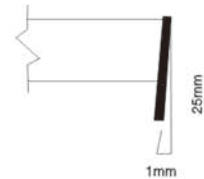

深加工焊接  
 前护板和包边板与每根受荷扁钢的焊接缝为大于或等于3mm的角焊  
 Deeply Processing Weld:  
 End plate and nosing's seams are 3mm or more then at every bearing bar's welding seam

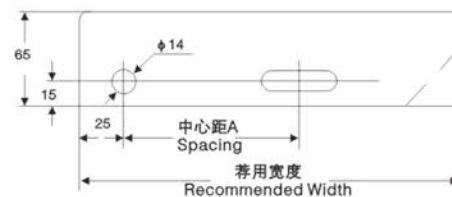

侧板用65X5的扁钢仅在客户要是倒角，以便安装（虚线为需要时倒角）  
 End plate uses 65X5 bearing bar Mitred only when requesting by customer in order to instal

◆ 踏步板数据型号/Stair Tread Data Type

荐用宽度 (mm) Recommended Width

T1-T4	125	155	185	215	245	275	305
	扁钢间距30mm Bearing Bars at 30mm Pitch						
T1-T2	125	165	--	205	245	285	325
	扁钢间距40mm Bearing Bars at 40mm Pitch						
T3-T4	115	155	--	195	235	275	315
	扁钢间距40mm Bearing Bars at 40mm Pitch						
T1-T2	--	--	185	--	245	--	305
	扁钢间距60mm Bearing Bars at 60mm Pitch						
T3-T4	--	155	--	215	--	275	--
	扁钢间距60mm Bearing Bars at 60mm Pitch						
中心距 (A) Spacing	45	75	75	100	100	150	150

最大长度 (mm) Maximum Length

扁钢规格 Bearing Bars	25x3	25x5	32x5	40x5
扁钢间距30mm Bearing Bars at 30mm Pitch	550	900	1300	1600
扁钢间距40mm Bearing Bars at 40mm Pitch	450	750	1200	1500
扁钢间距60mm Bearing Bars at 60mm Pitch	--	550	850	1350

说明：踏步板可采用任何型号钢格板制造，尺寸亦可采用非标准规格  
 Notes: Stair Tread may be any types of grating. The size may be up to no-standard specification

SURFACE TREATMENT

扶手栏杆表面处理

对栏杆扶手的表面处理，可采用热浸锌、涂漆或不处理三种方法。推荐用热浸锌处理。

Regarding surface treatment, the hot-dip galvanized, painted & untreated are available, of which the hot-dip galvanized is recommended.

TYPE OF JUNKE STANCHION

郡科立柱型号

我们能生产并提供给客户以下18种栏杆立柱，公司也可根据客户的特殊要求进行定做。

The following 18 types of stanchions can be manufactured for customers.

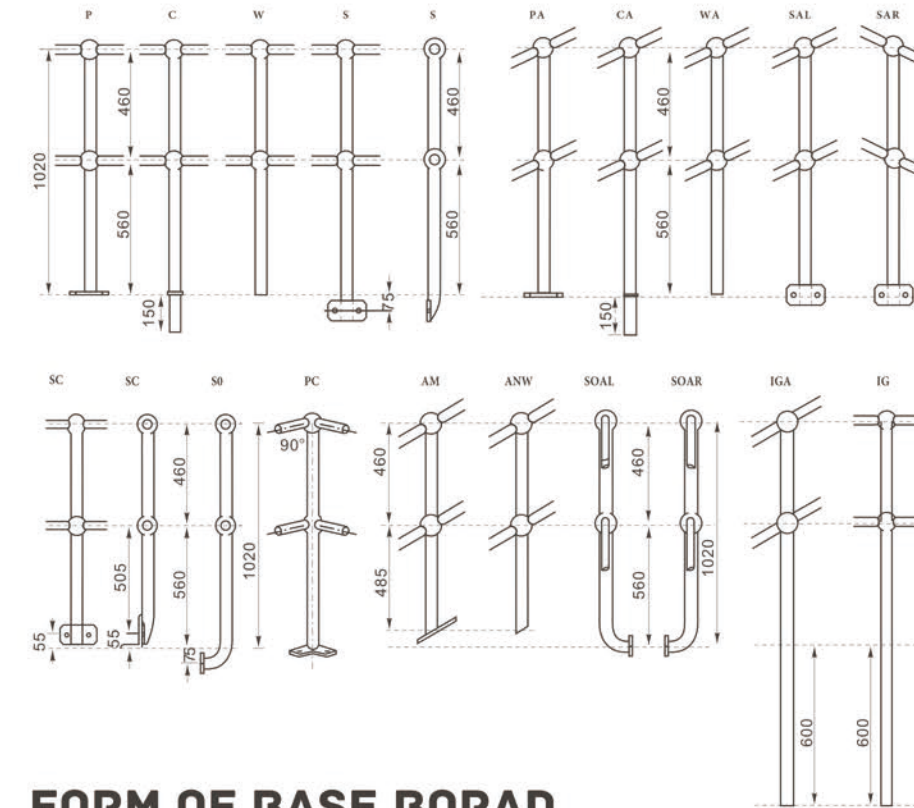

FORM OF BASE BORAD

立柱底板形式

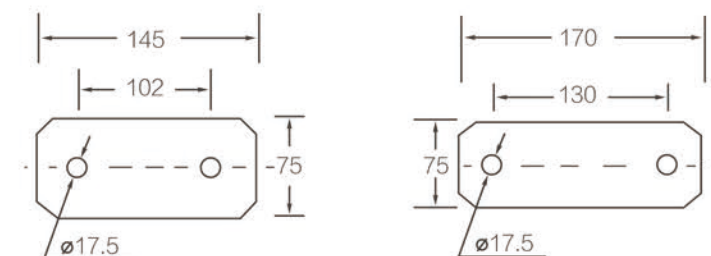



## RELATIONSHIP BETWEEN RAILING & STANCHION POST

栏杆型号与立柱关系

立柱 Stanchion		栏杆 Railing	
球直径 Ball diameter	立柱直径 Stanchion diameter	扶手型号 Type of Handrail	横杆型号 Type of Transverse Lever
66	42.3	33.5×3.25 L=6000mm	26.8×2.75 L=6000mm
78	48	42.3×3.25 L=6000mm	33.5×3.25 L=6000mm

- 注: 1.立柱间距以1米为宜。  
1 meter of distance is recommended between two stanchions.
- 2.立柱与栏杆的固定推荐采用自攻螺栓。  
Tapping screw is recommended for railing installation.

## FORM OF ELBOW / 弯头

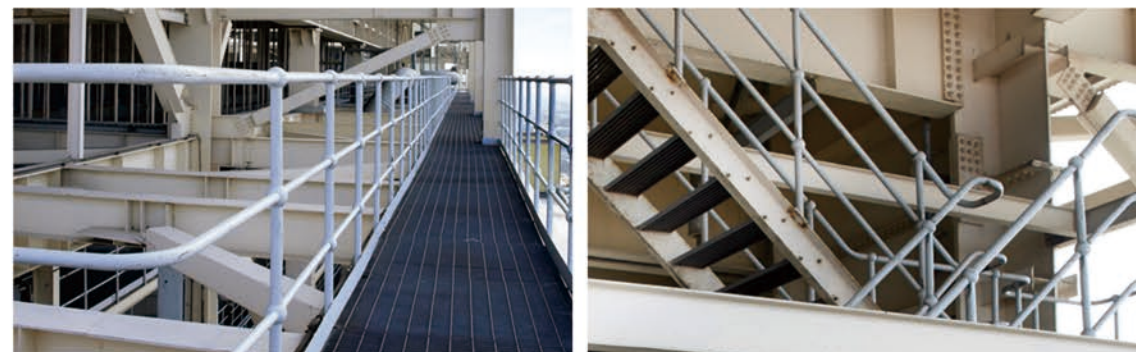
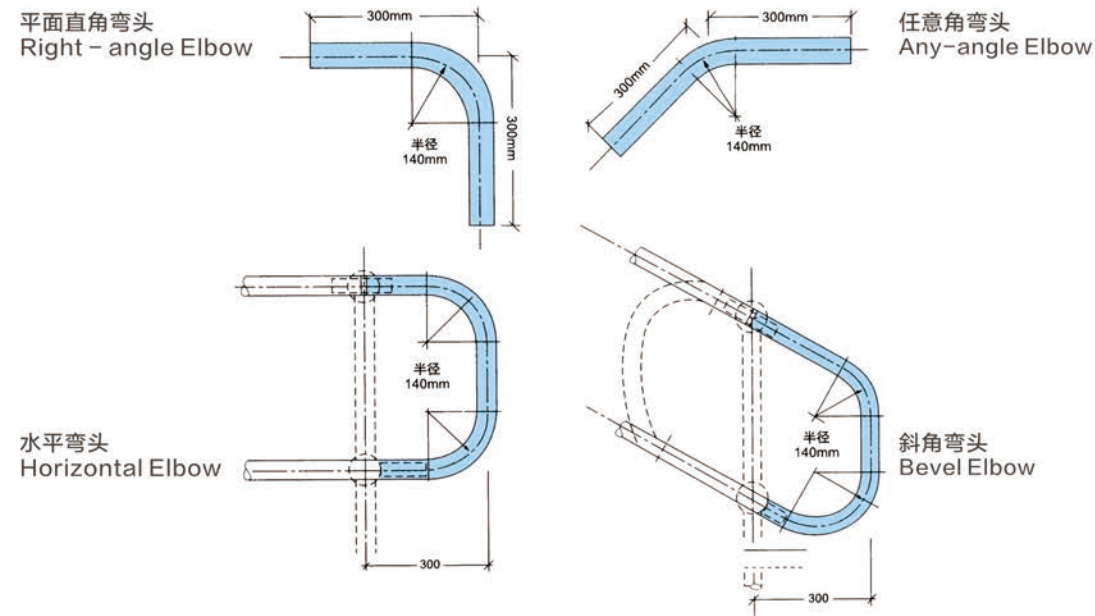

## PRODUCTS SHOW 产品展示

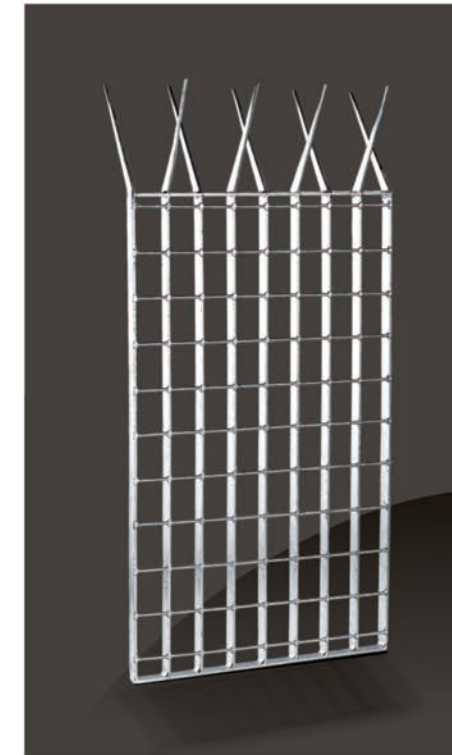

围栏  
Fence

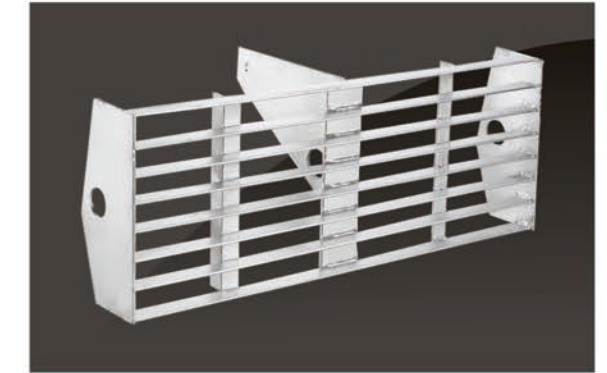

旋转踏步板  
Rotating step



镀锌花纹板  
Galvanized Checker Plate

复合板  
compound grating



热镀锌原板  
Standard Grating Panels

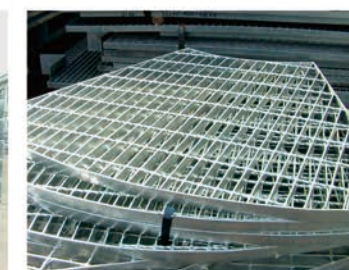

扇形平台板  
Fan Steel Grating

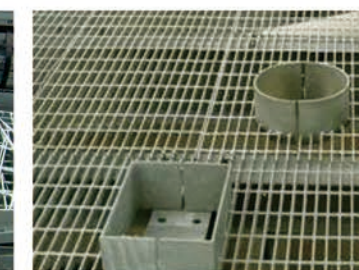

踢脚板钢格板  
Kick Plate Grating



防盗井盖  
Anti Theft Trench Grating



井盖  
Well Covers

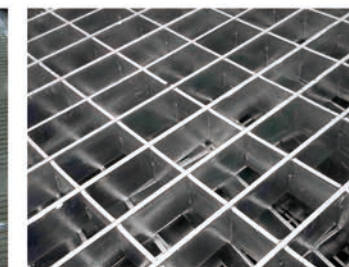

对插钢格板  
Press Locked Grating

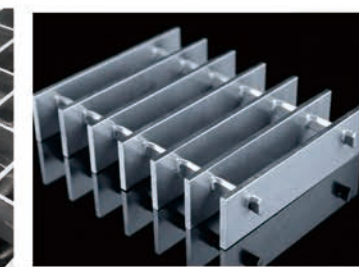

铝格栅  
Aluminium Grating

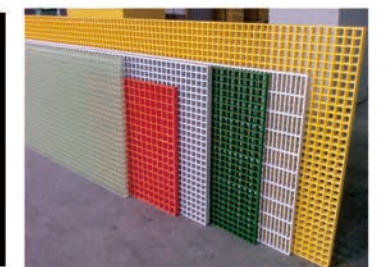

玻璃钢格栅  
Fiberglass Grating





### Resin Base

Resin type	Resin base	Description	Corrosion resistance	Flame spread Rating ASTM E84	Colors available
VEFR-25	Vinyl ester	Superior corrosion resistance and Retardant	Excellent	Class 1,25 or less	Dark gray,orange
VEFR-10	Vinyl ester	Superior corrosion resistance and enhanced retardant	Excellent	Class 1,10 or less	Dark gray
IFR-25	Isophthalic polyester	Industrial grade corrosion Resistance and fire Retardant	Very good	Class 1,25 or less	Dark gray,Green
IFR-10	Isophthalic Polyester	Industrial grade corrosion resistance and extra fire retardant	Very good	Class 1,10 or less	custom
IFGR-30	Isophthalic polyester	Food grade corrosion resistance and fire retardant	Very good	Class 1,25 or less	Light gray,light green
OFR-25	Ortho	Moderate corrosion resistance and fire retardant	Moderate	Class 1,25 or less	Green,yellow light gray,dark gray
MP-5	Phenolic Resin	Low smoke and superior fire resistance	Very good	Class 1, 5 or less	Reddish-brown, phenolic painting of the grating can be performed to obtain a gray or red finish
O-CR	Ortho	Moderate corrosion resistance	Moderate	No	Green,yellow light gray,dark gray

#### Fiberglass roving yarn

The fiberglass roving yarn in our company is bought from JUSHI GROUP or OCV with high quality. There are two kinds of fiberglass roving yarn in our company, which are C-Glass Assembled Rovings and E-Glass Direct Rovings.

E-Glass Direct Rovings for LFT are designed for reinforcing PP and PA resins.

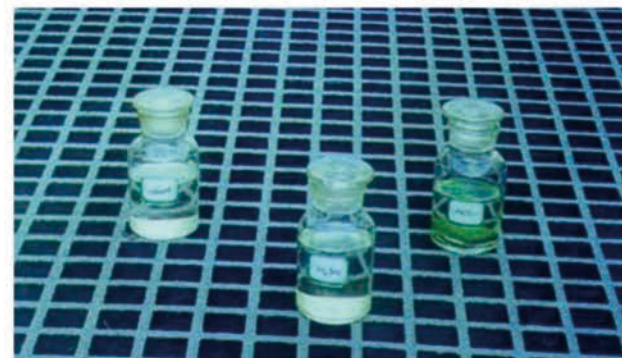

### JUNKE Molded Gratings

JUNKE FRP molded grating is manufactured in an open, heated mold system. Continuous E-glass roving's are placed in the mold in alternating layers and completely wetted out with resin. This continuous process produces an integral, one piece construction which provides excellent corrosion resistance as well as bi-directional strength. There are a number of different molds available resulting in an extensive range of panel sizes, thickness and mesh patterns.

#### Industries

- Chemical plant and metal finishing;
- Construction engineering, traffic and transportation
- Petrochemical engineering, ocean survey, water engineering
- Food and beverage plants
- Textile printing and dyeing and electronic industry

#### Functions:

- Anti-slip floor, stair tread, foot bridge
- Operation platform, trench cover
- Security and safety fence, handrail
- Off-shore oil rig, shipyard, shipping deck, ceiling
- Ramp ladder, scaffold, railway
- Decorative grid, man-made fountain pool grid
- Non-conductive and non-magnetic

#### Advantages:

- Anti-fire
- Anti-corrosion and anti-aging
- Anti-slippery
- Light but high loaded strength
- Long service life and maintenance free
- Non-conduction or magnetic
- Easy installation and rich colors
- Various size and colors available

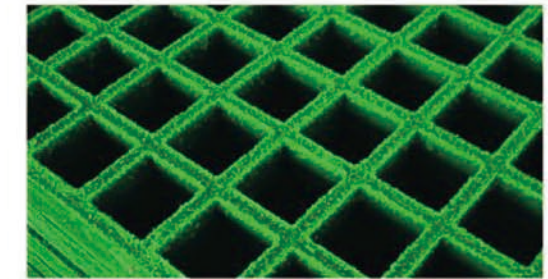

#### Surfaces



Concave

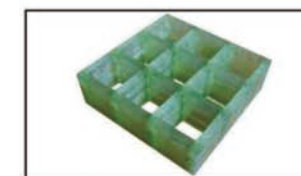

Smooth Surface



Diamond Top Cover



Gritted Top Cover

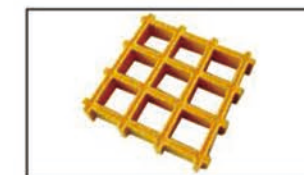

Gritted

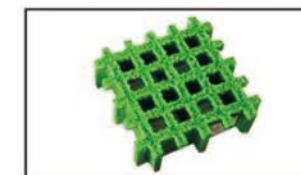

Mini mesh Surface

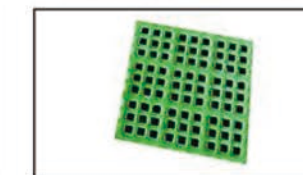

Micro mesh surface

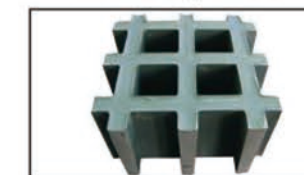

Heavy duty





**JUNKE FRP molded grating in details**

(Thickness-T)

**38×38**

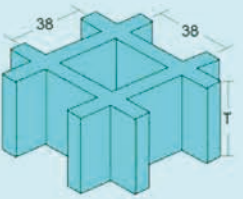
Legend	Thickness (mm)	Bar thickness (Top/Bottom)	Mesh size (mm)	Panel Size available (mm)	Weight (kg/m <sup>2</sup> )	Open Rate (%)
	13	6.0/5.0	38×38	1220×3660, 1220×4000, 1220×2440, 921×3055, 1264×4010	6.0	78
	14	6.0/5.0	38×38	1220×3660, 1220×4000, 1220×2440, 921×3055, 1264×4010	6.5	78
	15	6.0/5.0	38×38	1220×3660, 1220×4000, 1220×2440, 921×3055, 1264×4010	7.0	78
	20	6.0/5.0	38×38	1220×3660, 1220×4000, 1524×4010, 997×3012	9.8	65
	25	6.0/5.0	38×38	1220×3660, 1226×4010, 1530×4010, 921×3055, 1524×4000, 997×3012	12.5	68
	30	6.5/5.0	38×38	1220×3660, 1220×4010, 921×3055, 1524×4010	14.6	68
	38	7.0/5.0	38×38	1220×3660, 1220×4010, 2100×4240, 998×4010, 1220×2440, 921×3055, 1530×4010, 1530×3050, 1000×4000, 1226×3665	19.5	68
	50	9.5/7.5 heavy duty	38×38	1220×4010, 1220×3666, 1230×4010, 1220×2440, 921×3055	42	56
	60	10.5/8.5 heavy duty	38×38	1230×4010	50.4	54
	70	11.0/9.0 heavy duty	38×38	1230×4010	58.8	49

**40×40**

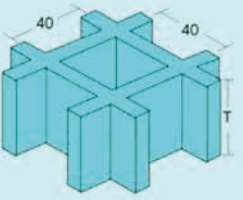
Legend	Thickness (mm)	Bar thickness (Top/Bottom)	Mesh size (mm)	Panel Size available (mm)	Weight (kg/m <sup>2</sup> )	Open Rate (%)
	25	7.0/5.0	40×40	1007×3007, 1007×4007, 1247×4047, 1527×4047	12.3	67
	30	7.0/5.0	40×40	1527×4047, 1007×3007, 1247×4047	14.6	67
	38	7.0/5.0	40×40	1527×4047, 1247×4047, 1007×3007, 1007×4047	19.2	67
	40	7.0/5.0	40×40	1527×4047, 1007×3007, 1007×4047, 1247×4047	19.5	67

**50×50**

Legend	Thickness (mm)	Bar thickness (Top/Bottom)	Mesh size (mm)	Panel Size available (mm)	Weight (kg/m <sup>2</sup> )	Open Rate (%)
	15	6.0/5.0	50×50	1228×4020, 1220×3600, 1220×2440	5.9	82
	40	6.8/5.0	50×50	1787×4530, 1225×4530	17.5	80
	25	7.0/6.0	50×50	1220×3660, 1226×4020, 1220×2440, 915×3050	11.5	78

**83×83**

Legend	Thickness (mm)	Bar thickness (Top/Bottom)	Mesh size (mm)	Panel Size available (mm)	Weight (kg/m <sup>2</sup> )	Open Rate (%)
	40	7.0/5.0	83×83	1007×4007, 1007×3007, 1007×4225	11.0	84

**13×13/40×40 micro mesh**

Legend	Thickness (mm)	Bar thickness (Top/Bottom)	Mesh size (mm)	Panel Size available (mm)	Weight (kg/m <sup>2</sup> )	Open Rate (%)
	25	6.5/4.5/5.0	13×13 40×40	1247×4047, 1007×3007, 1007×4047, 1530×4047	17.8	30
	30	6.5/4.5/5.0	13×13 40×40	1527×4047, 1247×4047, 1007×3007, 1007×4047	19.1	30
	38	6.5/4.5/5.0	13×13 40×40	1527×4047, 1247×4047, 1007×3007, 1007×4047	23.8	30

**19×19/38×38 mini mesh**

Legend	Thickness (mm)	Bar thickness (Top/Bottom)	Mesh size (mm)	Panel Size available (mm)	Weight (kg/m <sup>2</sup> )	Open Rate (%)
	25	6.5/5.0	19×19 38×38	1220×3660, 1220×2240, 921×3055, 1226×4007, 1268×4007	16.8	30
	30	6.5/5.0	19×19 38×38	1220×3660, 1220×2240, 915×3055, 1220×4000, 1530×4047	18.8	30
	38	6.5/5.0	19×19 38×38	1220×3660, 1220×2240, 915×3055, 1220×4000, 1226×4010	23.5	30

**20×20/40×40 mini mesh**

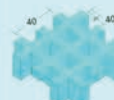
Legend	Thickness (mm)	Bar thickness (Top/Bottom)	Mesh size (mm)	Panel Size available (mm)	Weight (kg/m <sup>2</sup> )	Open Rate (%)
	14	6.5/5.0	20×20 40×40	1247×4047, 1007×3007	10.5	42
	22	6.5/5.0	20×20 40×40	1247×4047, 1007×3007, 1527×4047	14.8	42
	25	6.5/5.0	20×20 40×40	1247×4047	16.8	42
	30	7.0/5.0	20×20 40×40	1007×4047, 1007×3007, 1247×4047, 1527×4047	18.3	42
	38	7.0/5.0	20×20 40×40	1007×4047, 1007×3007, 1247×4047, 1527×4047	23.2	42
	40	7.0/5.0	20×20 40×40	1007×4047, 1007×3007, 1247×4047, 1527×4047	23.7	42

**25×100/100×25**

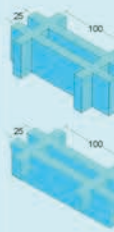
Legend	Thickness (mm)	Bar thickness (Top/Bottom)	Mesh size (mm)	Panel Size available (mm)	Weight (kg/m <sup>2</sup> )	Open Rate (%)
	25	7.0/5.5	100×25	1007×3007, 1007×4007, 1500×4028	13.0	67
	25	7.0/5.5	25×100	1220×3660, 915×3050	13.83	67
	25	9.5/8.0 heavy duty	100×25	1220×3660, 1220×2440, 915×3050	19.5	52
	30	7.0/5.5	100×25	1007×3007, 1007×4007	15.6	67
	38	8.0/6.0 heavy duty	100×25	1220×3660	22.8	62
	38 (T-shape)	15.0/5.0	25×100	1220×3660, 1225×4170	21	62

**38×38 Phenolic grating**

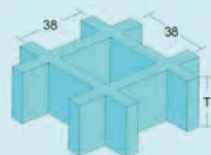
Legend	Thickness (mm)	Bar thickness (Top/Bottom)	Mesh size (mm)	Panel Size available (mm)	Weight (kg/m <sup>2</sup> )	Open Rate (%)
	38	7.0/5.0	38×38	1220×3660, 1416×3660, 1416×4010	19.5	68

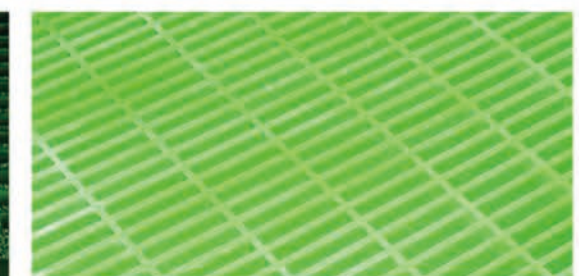
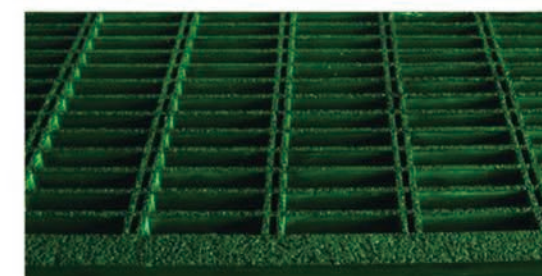
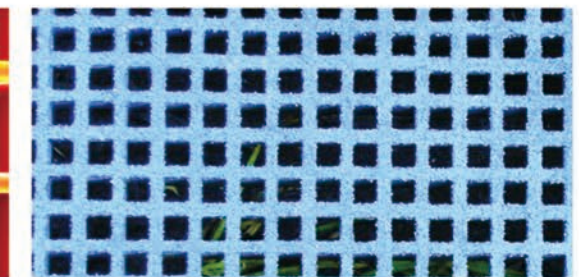
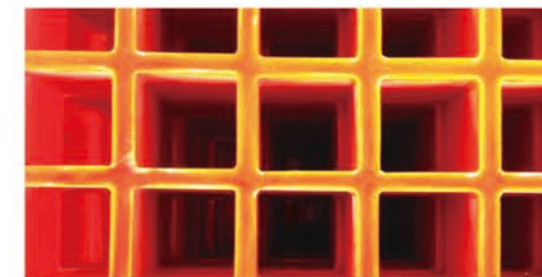

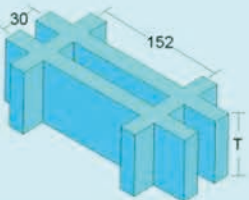

**38 × 152 Phenolic grating**

Legend	Thickness (mm)	Bar thickness (Top/Bottom)	Mesh size (mm)	Panel Size available (mm)	Weight (kg/m <sup>2</sup> )	Open Rate (%)
	38 (T-shape)	15.0/8.0	38 × 152	1500 × 3660	19.0	62

**Installation Fixing for Molded Gratings**

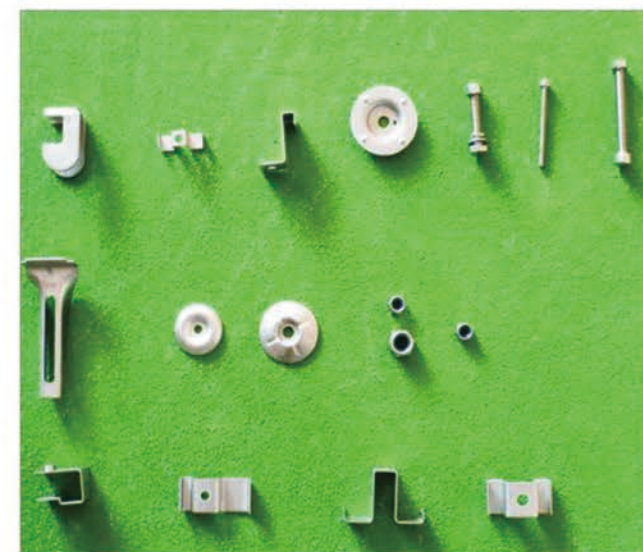
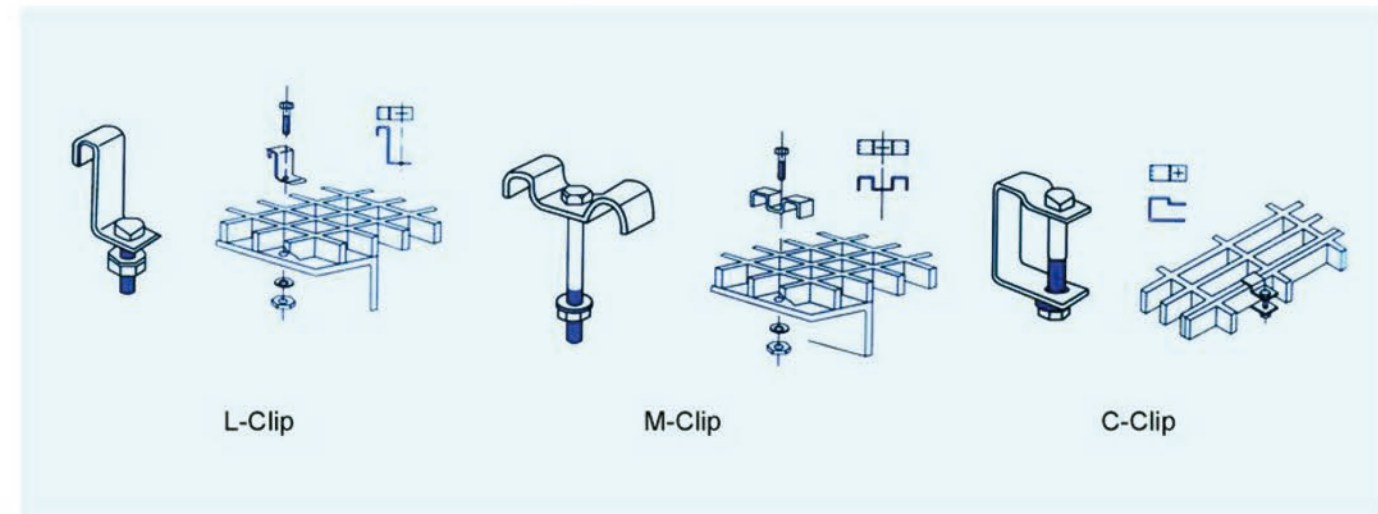

**Chemical resistance chart of molded grating**

Chemical	Max. Oper. Temp			
	%Conc.	Type 'vinyl'	Type 'Iso'	Type 'Ortho'
Hydrochloric acid	30	82	65	N/R
Nitric acid	35	38	N/R	N/R
Sulphuric acid	25	82	65	N/R
Hydrofluoric acid	10	24	N/R	N/R
Lactic acid	100	82	65	60
Hypochlorous acid	SAT	60	N/R	N/R
Citric acid	ALL	49	N/R	N/R
Potassium hydroxide	10	49	N/R	N/R
Sodium hydroxide	10	82	N/R	N/R
Calcium hydroxide	25	82	65	N/R
Calcium hypochloride	25	82	65	N/R
Ferric chloride	100	82	65	60
Aluminium chloride	ALL	82	65	60
Mercuric chloride	100	82	65	60
Silver nitrate	100	82	65	60
Sodium salt	ALL	24	N/R	N/R
Zinc chloride	ALL	24	24	N/R
Acetone	100	124	N/R	N/R
Chloroform	100	N/R	N/R	N/R
Fuel	All	38	38	38
Nantlkite	ALL	82	65	60
Phenols	10	24	N/R	N/R
Ozone	ALL	38	38	38
Bleaching liquid	ALL	82	N/R	N/R
Ammonium hydroxide	30	24	N/R	N/R
Ammonium salt	ALL	24	N/R	N/R
Black sewage	ALL	82	N/R	N/R
Cupric oxide	ALL	52	52	N/R
Glyclo	100	82	65	60
Sulfur dioxide	SAT	82	65	60
Sodium phosphate	50	82	N/R	N/R
Water	100	82	65	60
Alum	ALL	82	65	60
Chlorine water	SAT	49	N/R	N/R

ALL-concentrations;SAT-saturated solution;N/R-not recommended;---on information available